





ASSEMBLY INSTRUCTION

No.	Drawing	Description	Q'ty
A		Allen key	1
B		5/16"-1-3/4"	8
C		5/16"*12mm	8
D		5/16"*16mm	8
E		Leg	2
F		Cushion	1

step1

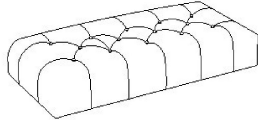
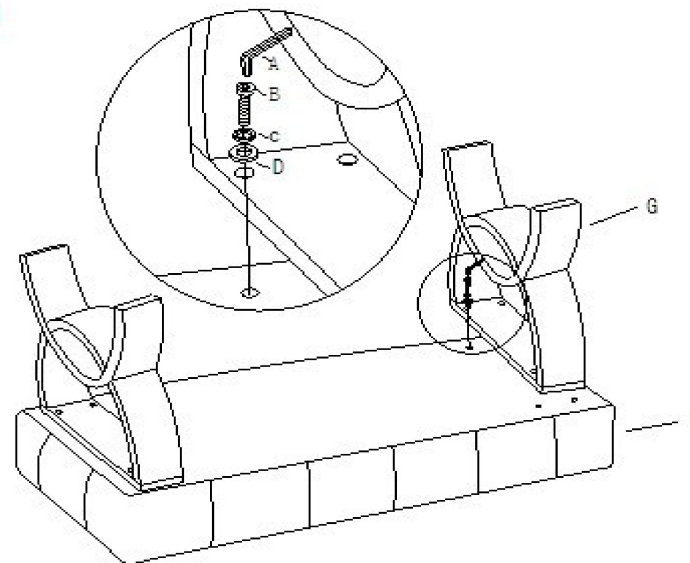

step2

