













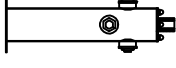

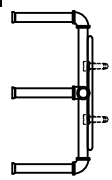

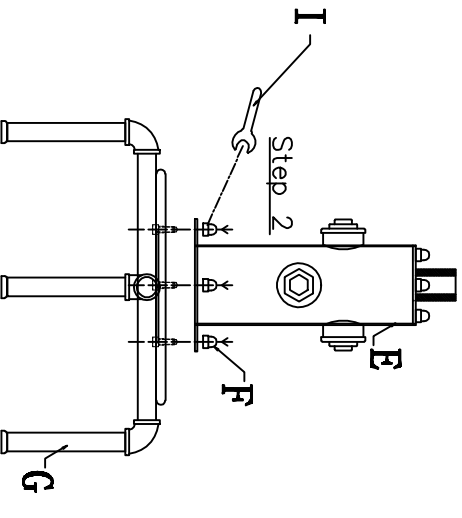
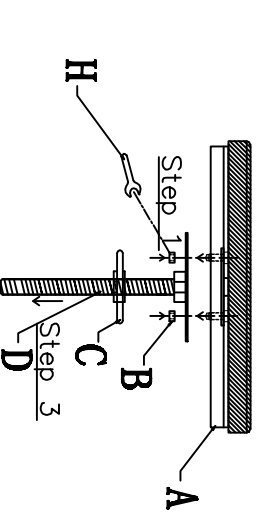
A	IPC	
B	M8*4PCS	
C	IPC	
D	IPC	
E	IPC	
F	M8*4PCS	
	H	
	12mm	IPC
G	IPC	
	I	
	14mm	IPC

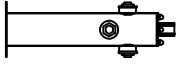

A	IPC	
B	M8*4PCS	
C	IPC	
D	IPC	
E	IPC	
F	M8*4PCS	
	H	
	12mm	IPC
G	IPC	
	I	
	14mm	IPC

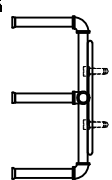